



N-Channel Enhancement Mode Power MOSFET

RY13N50

MAIN CHARACTERISTICS

I_D	13A
V_{DSS}	500V
$R_{DS(on)-max}$ (@ $V_{GS}=10V$)	0.45 Ω
Q_G -typ	40nC

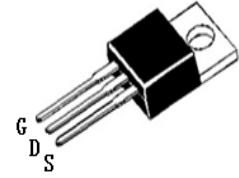
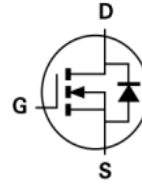

RYF13N50C/T0-220C

FEATURES

- Fast Switching
- Low ON Resistance
- Low Gate Charge
- 100% Single Pulse avalanche energy Test

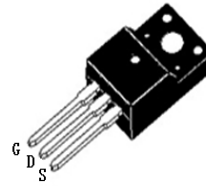

RYF13N50F/T0-220F

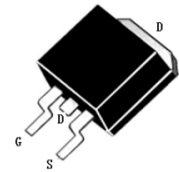

RY13N50A3/T0-263

APPLICATIONS

- Power switch circuit of adaptor and charger.

MECHANICAL DATA

- Case: Molded plastic
- Mounting Position: Any
- Molded Plastic: UL Flammability Classification Rating 94V-0
- Lead free in compliance with EU RoHS 2011/65/EU directive
- Solder bath temperature 275°C maximum, 10s per JESD 22-B106

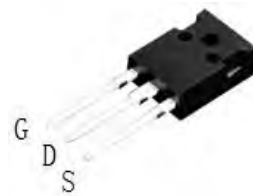

RY13N50A7/T0-247

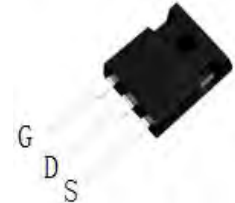

RY13N50A7/T0-247S

Marking on the body



MAKING:

X X X X X X

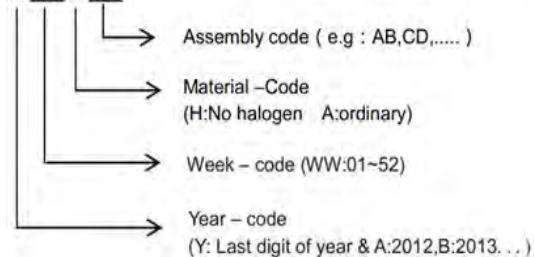

Ordering information

Part Number	Package	Unit Weight	Base Quantity	Delivery mode
RYF13N50C	T0-220C	0.07oz(1.96g)	50 pcs / tube	1Kpcs/box 5Kpcs/carton
RYF13N50F	T0-220F	0.06oz(1.74g)	50 pcs / tube	1Kpcs/box 5Kpcs/carton
RY13N50A3	T0-263	0.04oz(1.16g)	50 pcs / tube	1Kpcs/box 5Kpcs/carton
RY13N50A3	T0-263	0.04oz(1.16g)	800 pcs / reel	800pcs/box 4Kpcs/carton
RY13N50A7	T0-247	0.209oz(5.93g)	30 pcs / tube	600pcs/box 2.4Kpcs/carton
RY13N50A7	T0-247S	0.158oz(4.48g)	30 pcs / tube	600pcs/box 2.4Kpcs/carton



N-Channel Enhancement Mode Power MOSFET

RY13N50

Maximum Ratings at Tc=25°C unless otherwise specified

Characteristics	Symbol	Value			Unit
		220AB/263	220F	247/247S	
Drain-Source Voltage	V_{DS}	500			V
Gate-Source Voltage	V_{GS}	±30			V
Continue Drain Current	I_D	13			A
Pulsed Drain Current (Note1)	I_{DM}	52			A
Power Dissipation	P_D	190	48	150	W
Single Pulse Avalanche Energy (Note1)	E_{AS}	840			mJ
Operating Temperature Range	T_J	150			°C
Storage Temperature Range	T_{STG}	-55 to +150			°C
Thermal Resistance, Junction to Case	$R_{\theta JC}$	0.83	2.98	0.83	°C/W
Thermal Resistance, Junction to Ambient	$R_{\theta JA}$	62.5	62.5	62.5	°C/W

Note1:Pulse test: 300 μs pulse width, 2 % duty cycle

Electrical Characteristics at Tc=25°C unless otherwise specified

Characteristics	Test Condition	Symbol	Min	Typ	Max	Unit
Drain-Source Breakdown Voltage	$V_{GS} = 0 V, I_D = 250 \mu A$	BV_{DSS}	500	-	-	V
Drain-Source Leakage Current	$V_{DS} = 500 V, V_{GS} = 0 V$	I_{DSS}	-	-	1	μA
Gate Leakage Current	$V_{GS} = \pm 30 V, V_{DS} = 0 V$	I_{GSS}	-	-	±100	nA
Gate-Source Threshold Voltage	$V_{DS} = V_{GS}, I_D = 250 \mu A$	$V_{GS(th)}$	2	-	4	V
Drain-Source On-State Resistance	$V_{GS} = 10 V, I_D = 6.5 A$	$R_{DS(on)}$	-	-	0.45	Ω
Forward Transconductance	$V_{DS} = 15 V, I_D = 6.5 A$	g_{fs}	-	13	-	S
Input Capacitance	$V_{GS} = 0 V, V_{DS} = 25 V, f = 1 MHz$	C_{iss}	-	1950	-	pF
Output Capacitance		C_{oss}	-	195	-	pF
Reverse Transfer Capacitance		C_{rss}	-	11	-	pF
Turn-on Delay Time(Note2)	$I_D = 13 A, V_{DD} = 250 V, R_G = 10 \Omega$	$t_{d(ON)}$	-	24	-	ns
Rise Time(Note2)		t_r	-	32	-	ns
Turn-Off Delay Time(Note2)		$t_{d(OFF)}$	-	38	-	ns
Fall Time(Note2)		t_f	-	23	-	ns
Total Gate Charge(Note2)	$I_D = 13 A, V_{DD} = 400 V, V_{GS} = 10 V$	Q_G	-	40	-	nC
Gate to Source Charge(Note2)		Q_{GS}	-	9	-	nC
Gate to Drain Charge(Note2)		Q_{GD}	-	14	-	nC

Source-Drain Diode Characteristics at Ta=25°C unless otherwise specified

Characteristics	Test Condition	Symbol	Min.	Typ.	Max.	Unit
Maximun Body-Diode Continuous Current		I_S	-	-	13	A
Maximun Body-Diode Pulsed		I_{SM}	-	-	52	A
Drain-Source Diode Forward Voltage	$I_{SD} = 13 A$	V_{SD}	-	-	1.4	V
Reverse Recovery Time(Note2)	$I_{SD} = 13 A, V_{GS} = 0 V, di_F / dt = 100 A/\mu s$	t_{rr}	-	550	-	ns
Reverse Recovery Charge(Note2)		Q_{rr}	-	4.5	-	μC

Note2:Pulse test: 300 μs pulse width, 2 % duty cycle



RY13N50

RATINGS AND CHARACTERISTIC CURVES

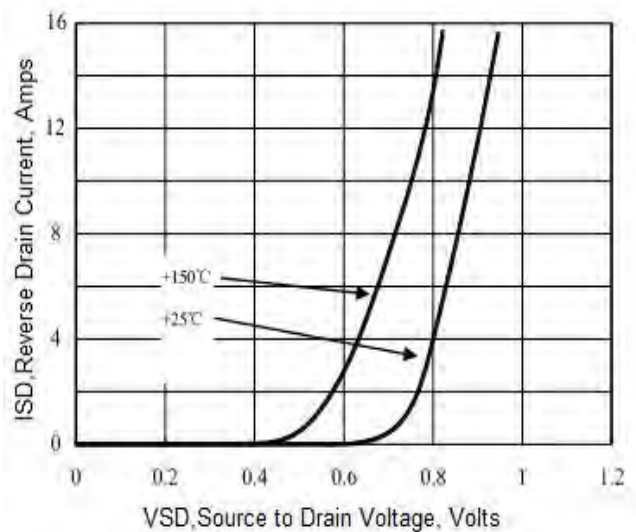
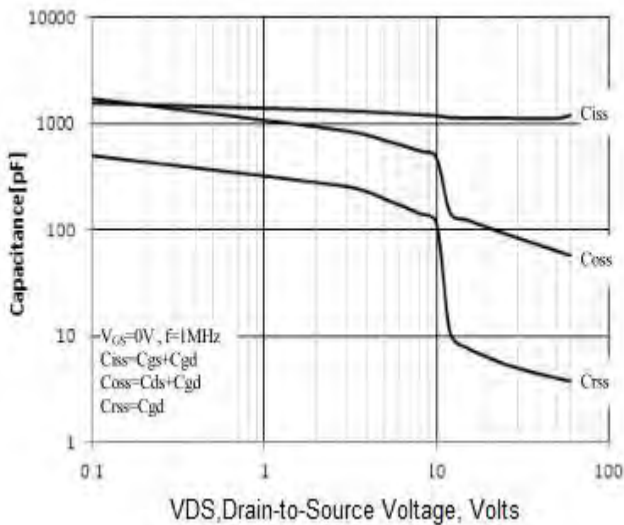
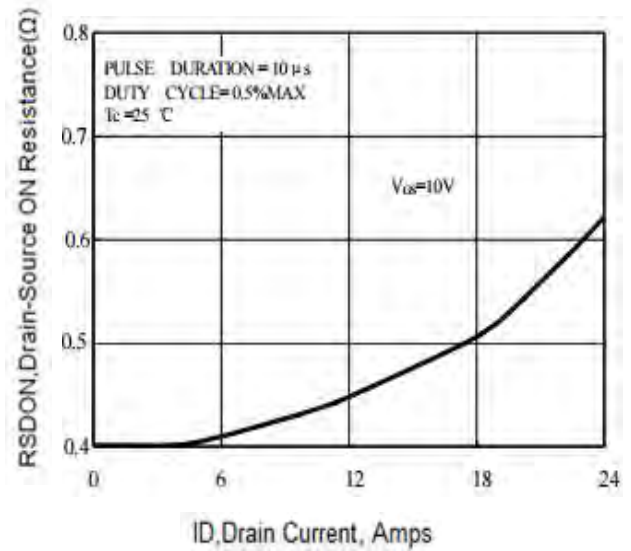
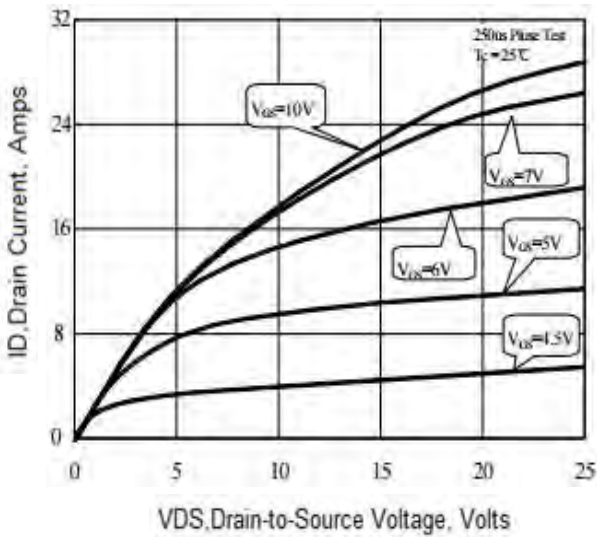
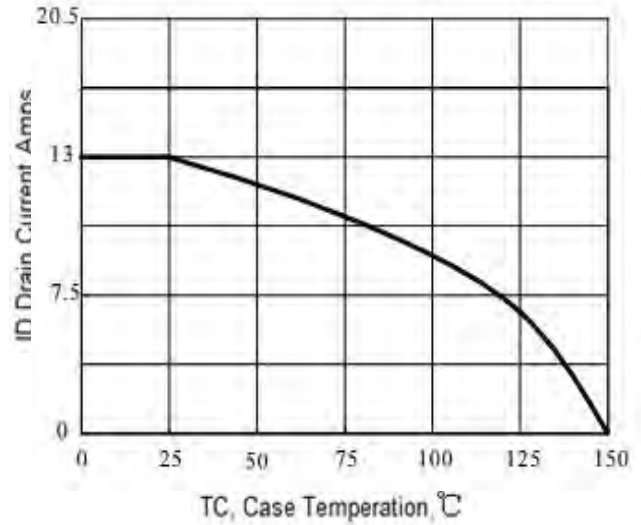
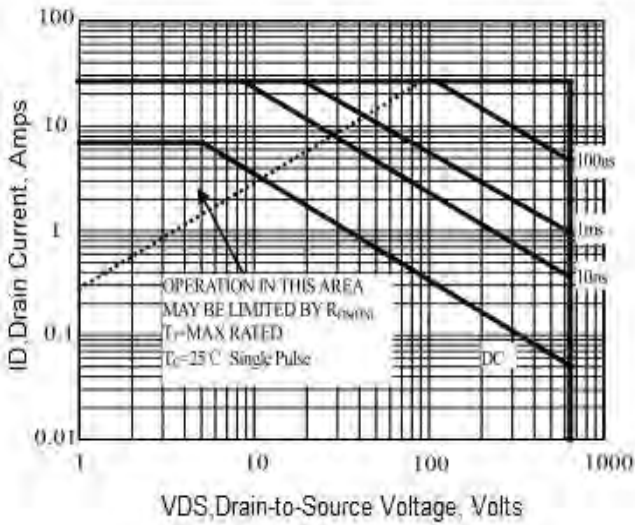

RY13N50

Package Outline Dimensions millimeters

TO-220AB

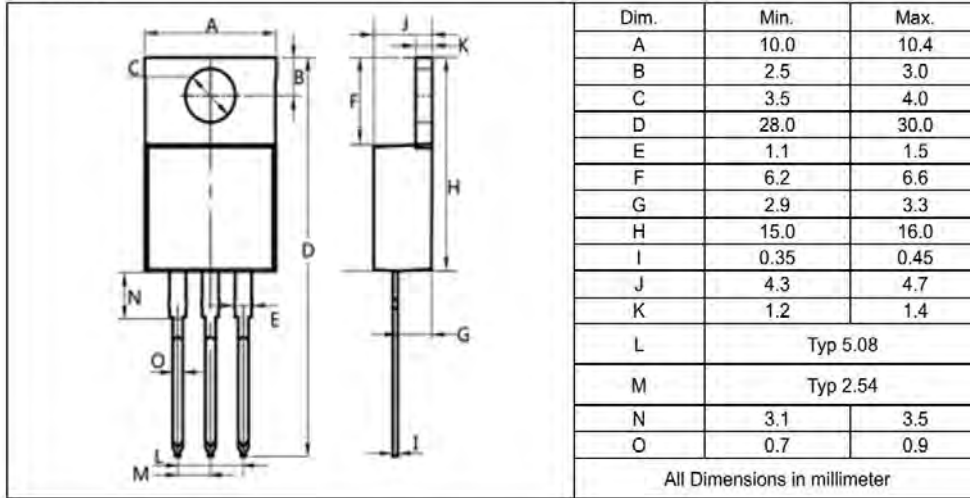

TO-220F

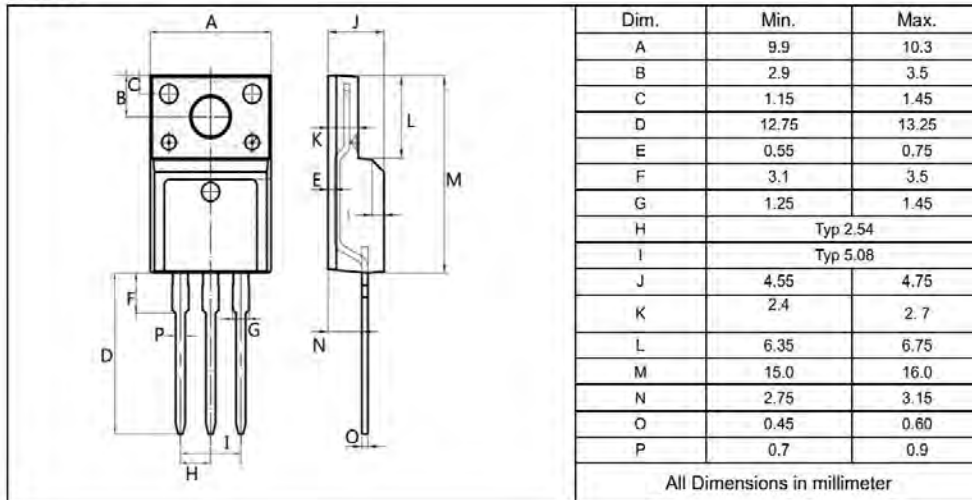

TO-263

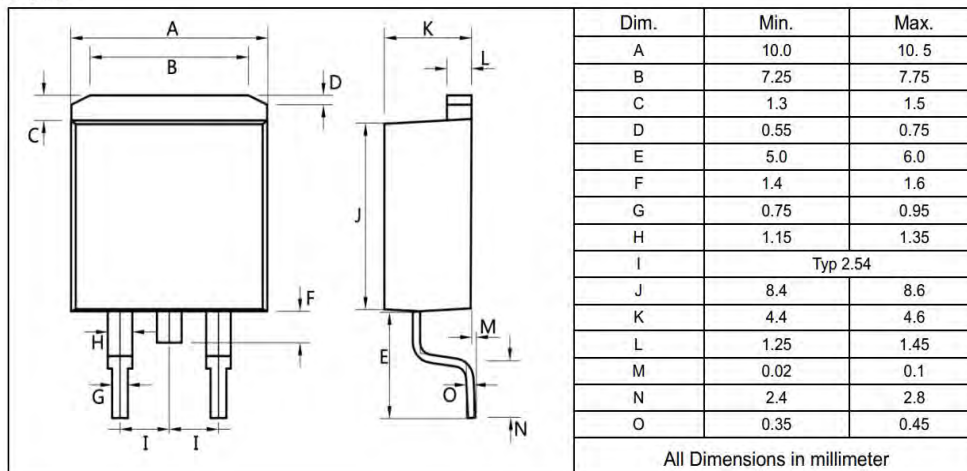

RY13N50

Package Outline Dimensions millimeters

TO-247

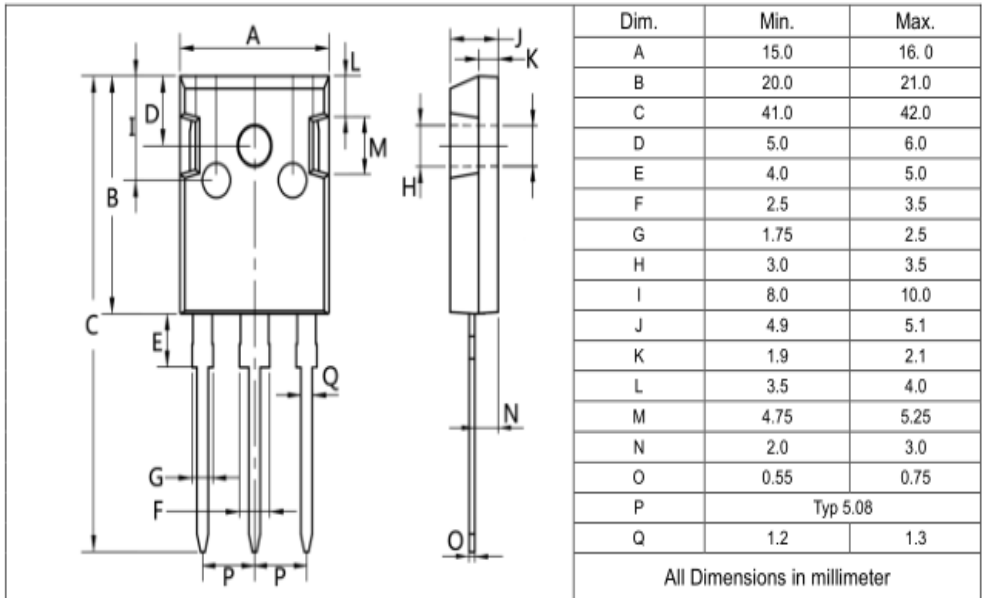

TO-247S

